

Article number: 0110077

Description: Retaining ring JS 62x3
Springsteel

Measures

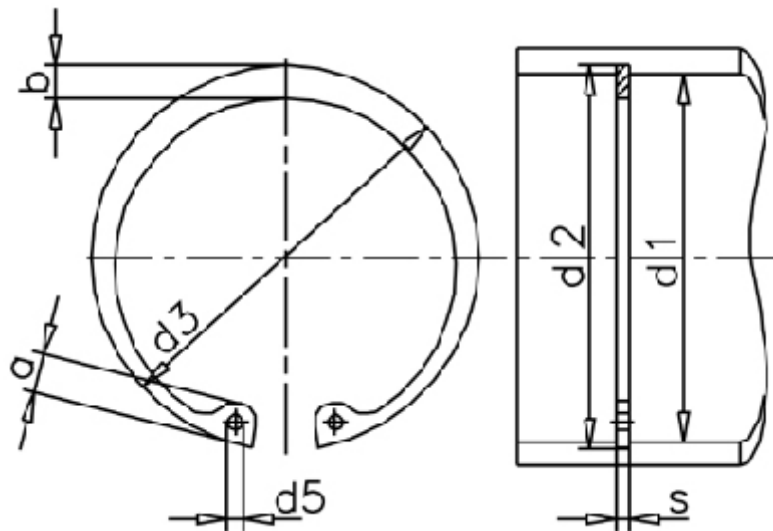

a max = 8.6	Description = JS 62	t = 1.50
AN mm ² = 299	FN kN = 49.8	tol = 0.30
B = 2.25	FRg kN = 29.2	tol = +1,10 -0,46
b = 5.5	FR kN = 137.0	tol = -0.08
d1 = 62	g = 2.0	Tong = ZGJ-3
d2 = 65.0	m min = 3.15	Weight kg/1000 = 16.1
d3 = 66.2	Nominal drive = 4.5	
d5 min = 2.5	s = 3.00	